

1592 OPEN

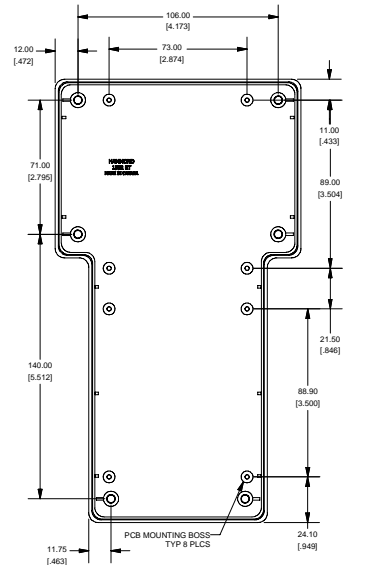

FRONT VIEW OF BOX

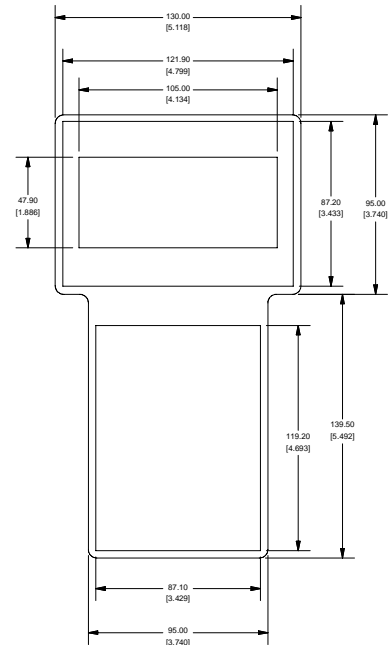
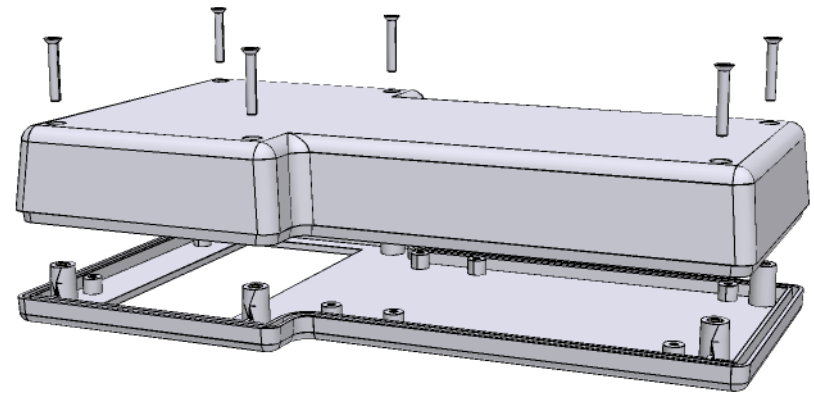
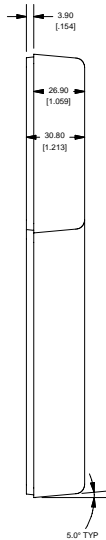

FRONT VIEW OF LID

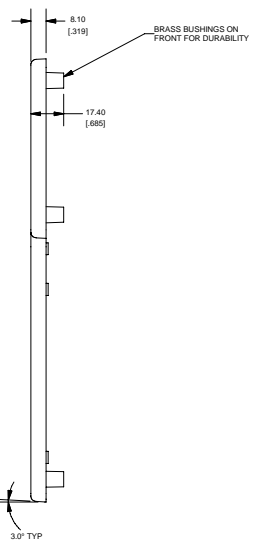

SECTION A-A SCALE 1 / 2

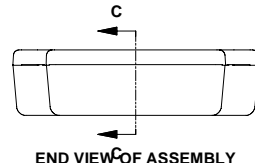

END VIEW OF ASSEMBLY

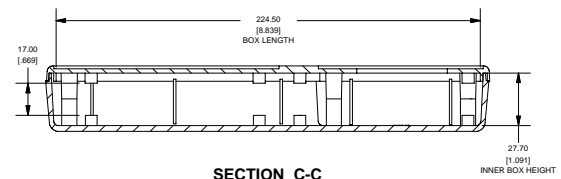

SECTION C-C SCALE 1 / 2

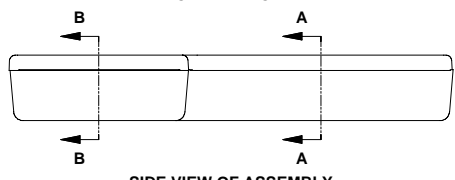

SIDE VIEW OF ASSEMBLY

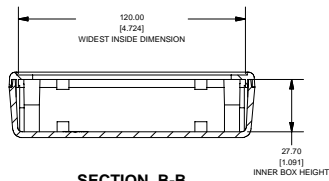
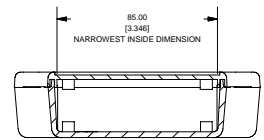

SECTION B-B SCALE 1 / 2



PART NUMBERS	
1592 Enclosure	
Grey case with open display insert and clear polycarbonate lens kit	1592ETCDGY
Black case with open display insert and clear polycarbonate lens kit	1592ETCDBK
Accessories	
Gasket kit with 76 cm (30") of gasket (for one unit)	1592ETG
Rubber Feet (package of 6)	1592ETRF
Magnetic Strip 7.62 cm (3") square	1592ETM
Velcro Mounting Tab	1592ETV
M3 - 0.5 x 20mm countersunk flat head replacement screws	1594MS100